



Russell Hobbs



24702

 www.russellhobbs.com

Register online for an EXTRA year guarantee

Visit uk.russellhobbs.com/product-registration You must register within 28 days of purchase

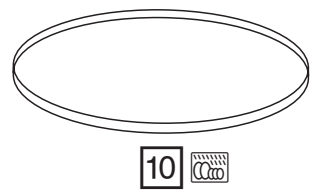
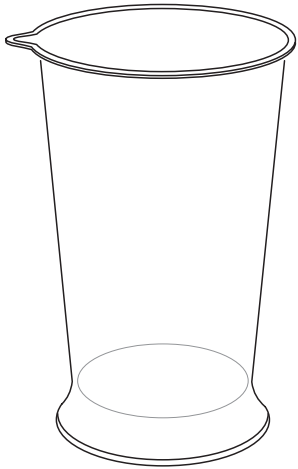
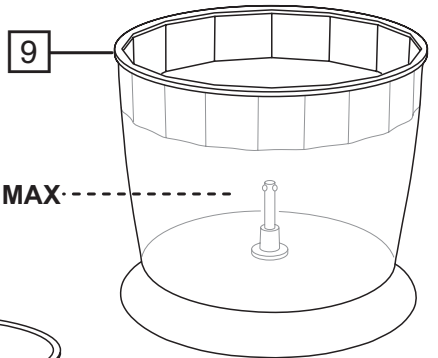
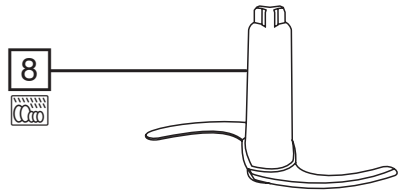
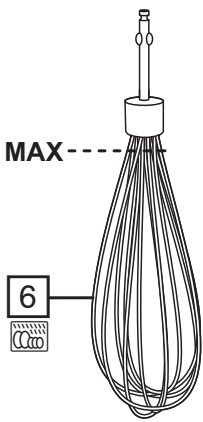
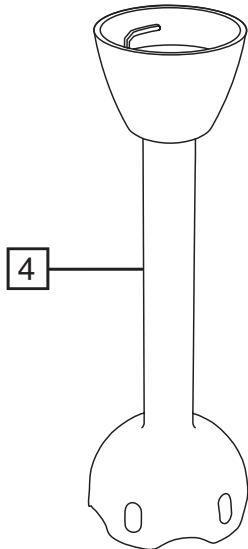
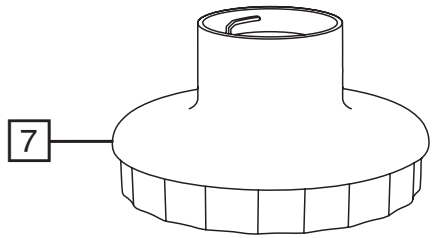
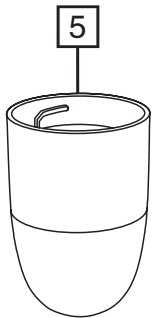
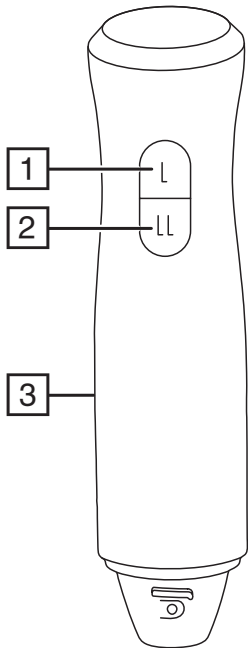

Read the instructions, keep them safe, pass them on if you pass the appliance on. Remove all packaging before use.

IMPORTANT SAFEGUARDS

Follow basic safety precautions, including:

This appliance can be used by persons with reduced physical, sensory or mental capabilities or lack of experience and knowledge if they have been supervised/instructed and understand the hazards involved. Children must not use or play with the appliance. Keep the appliance and cable out of reach of children.

 To avoid injury, take care handling the blades, emptying the bowl, and cleaning.

 Don't add hot liquid (over 40°C) to the bowl, as it may be ejected due to sudden steaming.

Misuse of the appliance may cause injury.

Unplug the appliance before assembly, disassembly, or cleaning.

Don't leave the appliance unattended while plugged in.

If the cable is damaged, it must be replaced by the manufacturer, its service agent, or someone similarly qualified, to avoid hazard.

-  Do not use this appliance near bathtubs, showers, basins or other vessels containing water.
- Don't use the wand in hot oil – even moderately hot oil can cause a nasty burn.
- Don't try to chip ice, don't try to chop raw meat, and take great care with the blades.
- Don't fit an attachment or accessory other than those we supply.
- Don't use the appliance for any purpose other than those described in these instructions.
- Don't operate the appliance if it's damaged or malfunctions.
- If blending hot liquids in a pan, always remove the pan from the heat and allow it to cool down a little before blending.
- Never leave the blender resting in the pan because the bottom of the pan could still be very hot and damage the blender.
- Don't use the wand for more than 30 seconds, the whisk for more than 5 minutes or the chopper for more than 30 seconds. Allow the motor to cool for 2 minutes before using it again.

HOUSEHOLD USE ONLY

DIAGRAMS

- | | |
|----------------------|---|
| 1. Low speed button | 7. Bowl lid |
| 2. High speed button | 8. Chopping blade |
| 3. Motor unit | 9. Bowl |
| 4. Wand attachment | 10. Non-slip base/cover |
| 5. Whisk holder | 11. Beaker |
| 6. Whisk attachment |  Dishwasher safe |

FITTING/REMOVING ATTACHMENTS

1. Unplug the appliance before fitting or removing attachments.
2. To fit an attachment, push it on to the end of the motor unit, and turn it clockwise.
3. To remove the attachment, turn it anti-clockwise, then pull the attachment off the motor unit.

USING

1. Put the plug into the power socket.
 2. Press the low speed button for low speed, release it to switch off.
 3. Press the high speed button for high speed, release it to switch off.
- Large quantities, thick mixes, and a high ratio of solids to liquids require longer timings and slower speeds.
 - Smaller quantities, thinner mixes, and more liquids than solids require shorter timings and higher speeds.

WAND ATTACHMENT

Use the wand attachment to blend, pulp or purée ingredients in the pan or bowl you're going to cook them in.

Whatever container you use, make sure it's on a stable, flat surface, and support it with your free hand to prevent it wandering over the work surface.

- Don't immerse the wand past the top of the parallel-sided tube.
- When using it in hot liquids, don't let the blade break the surface at an angle, as you might spray liquid outside the bowl/pan/container.
- Don't switch on till the blade is inside the food container.
- Switch off before lifting the blade from the food container.

WHISK ATTACHMENT

Use the whisk where you would have normally used a hand whisk.

- Push the whisk into the bottom of the whisk holder.
- To remove the whisk, simply pull it out of the bottom of the whisk holder,
- Don't immerse the whisk past the bottom of the whisk holder.

CHOPPING ATTACHMENT

You can use the chopper as a mini food processor.

1. Unplug the motor unit.
2. Handle the chopping blade only by the plastic part. Lower it into the bowl over the spindle in the bottom of the bowl.
3. Add the ingredients – don't fill the bowl above the 700ml mark.
4. Fit the bowl lid – the top of the chopper fits into the drive in the underside of the lid.
5. Fit the motor unit to the top of the bowl lid.
6. Use the chopper in bursts of a few seconds, otherwise you risk overdoing it.
7. When finished, unplug the motor unit then remove it from the lid.
8. Lift the lid gently from the bowl – take care that any drips fall into the bowl. Lift out the chopping blade.
9. For storage, you may use the non-slip base as a lid.

CARE AND MAINTENANCE

1. Unplug the appliance.
2. Wipe all surfaces with a clean damp cloth.
3. For best results, wash the wand immediately after use. Clean the blade end of the wand in hot soapy water with a nylon brush. Do not wash the wand in a dishwasher. Always ensure that the wand is dried thoroughly before storing. If water enters the wand, stand it up inverted until all of the water has drained away.
4. Keep the whisk holder and bowl lid dry, as they contain the gearboxes for the whisk and bowl.
5. Wash the whisk, beaker, bowl, and non-slip base in warm soapy water.



You may wash these parts in a dishwasher.

If you use a dishwasher, the harsh environment inside the dishwasher will affect the surface finishes. The damage should be cosmetic only, and should not affect the operation of the appliance.

RECIPE

BANANA SORBET

- 300g frozen banana chopped into 10-15mm pieces
- 200 ml honey
- 2.5 ml vanilla extract

Process the ingredients with the chopping attachment for 5 seconds.

RECYCLING



To avoid environmental and health problems due to hazardous substances, appliances and rechargeable and non-rechargeable batteries marked with one of these symbols must not be disposed of with unsorted municipal waste. Always dispose of electrical and electronic products and, where applicable, rechargeable and non-rechargeable batteries, at an appropriate official recycling/collection point.

SERVICE

If you ring Customer Service, please have the Model Number to hand, as we won't be able to help you without it. It's on the rating plate (usually underneath the product).

The product isn't user-serviceable. If it's not working, read the instructions, check the plug fuse and main fuse/circuit breaker. If it's still not working, consult your retailer.

If that doesn't solve the problem – ring Customer Service – they may be able to offer technical advice.

If they advise you to return the product to us, pack it carefully, include a note with your name, address, day phone number, and what's wrong. If under guarantee, say where and when purchased, and include proof of purchase (till receipt). Send it to:

Customer Service

Spectrum Brands (UK) Ltd

Fir Street, Failsworth, Manchester M35 0HS

email: support@russellhobbs.com

telephone: 0345 658 9700 (local rate number)

Please note: If you have purchased the product within the last 6 months, please contact the retailer in the first instance to deal with any matters relating to warranty.

GUARANTEE

Defects affecting product functionality appearing within the guarantee period will be corrected by replacement or repair at our option provided the product is used and maintained in accordance with the instructions. Your statutory rights are not affected.

Guarantee period = 2 years from first retail purchase.

To claim an extra 1 year guarantee, register your product online within 28 days of purchase.

Register at: uk.russellhobbs.com/product-registration

Consumables are guaranteed only for their recommended lifecycle. Replacement/Spare parts* are excluded and are only covered by a 1 year warranty.

* Examples include filters, removable grill plates, drip trays/crumb trays etc.

ONLINE

www.russellhobbs.com for more products